



INSTALLATION AND OPERATOR'S MANUAL
FOR

DCC-2500

Digital Climate Control for Vintage Air GEN-IV-V systems

PARTS INCLUDED WITH THIS SYSTEM

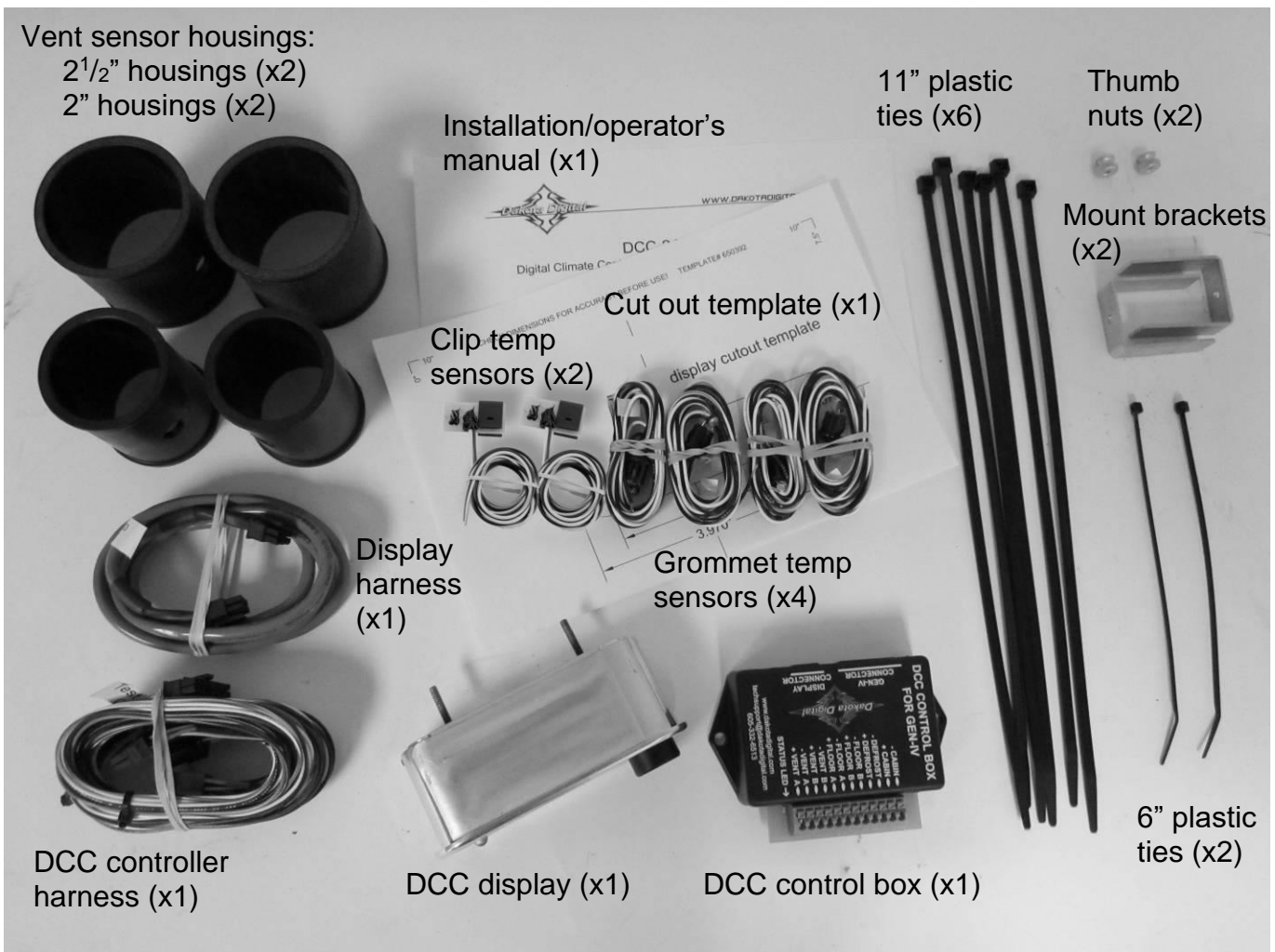

***GEN-IV-V: DCC-2500 compatible with both GEN-IV Systems and GEN-V Systems.**

CONNECTION DIAGRAM:

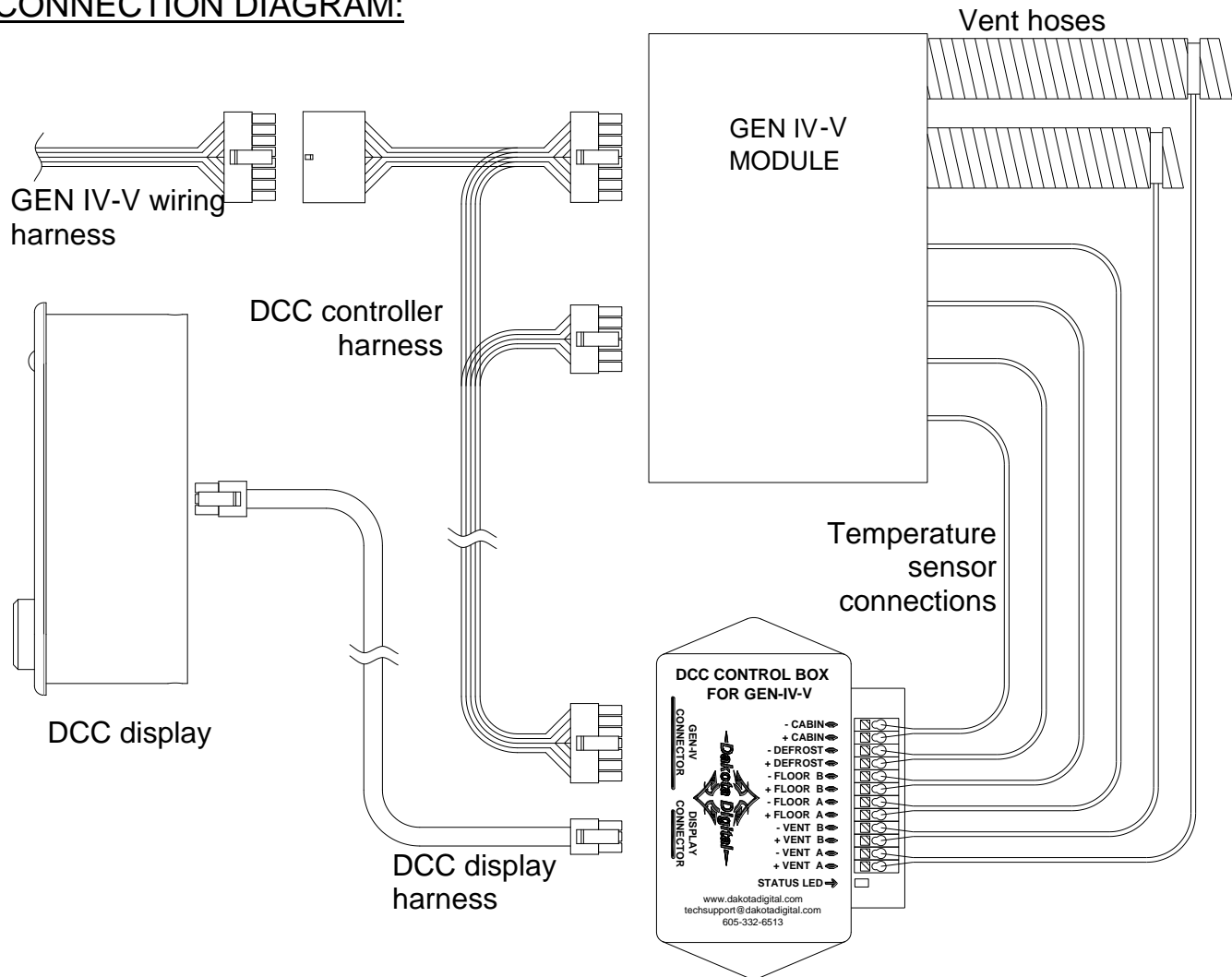

INSTALLATION:

NOTE: While installation is possible with the GEN-IV-V system already in the vehicle, it is easier to install some of the sensors when you have full access to all sides of the GEN-IV-V module. If the GEN-IV-V is not yet installed in your vehicle, we recommend installing the temperature sensors first.

STEP 1: INSTALLING THE DEFROST SENSOR

The supplied grommet type temperature sensors require a 3/8" hole to be drilled so they can be inserted into the housing. To prevent drilling too deeply, create a stop for your drill bit (see photos at right) with a piece of rubber hose or small block of wood that is long enough to allow just the tip (about 1/4") of the bit to protrude.

NOTE: As an alternative to drilling, one of the extra Vent Sensor Housings could be used to put the sensor in one of the defrost duct tubes. This should only be done if drilling the hole is difficult or impossible with an installed GEN-IV-V system. See STEP 5 for install method.

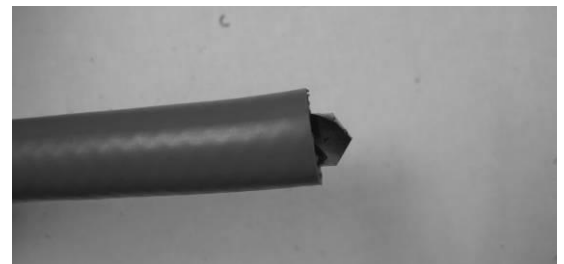
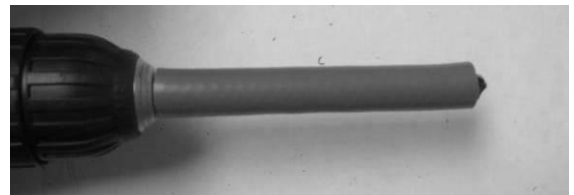

Using the 3/8" drill bit with the proper rubber or wood stop installed, drill a hole in the defrost duct in the location shown.

Insert one of the four supplied grommet type temperature sensors into the drilled hole with the wires pointing to the outside of the duct housing. The sensor should snap into the hole with the collar of the sensor resting against the housing.

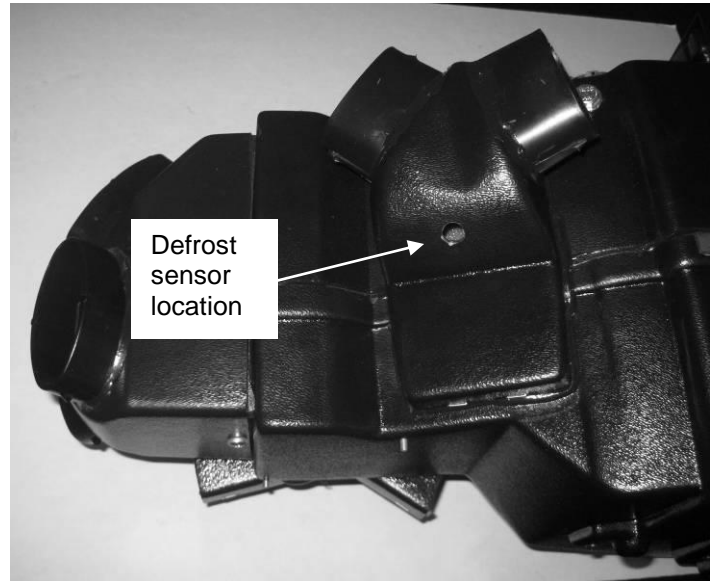
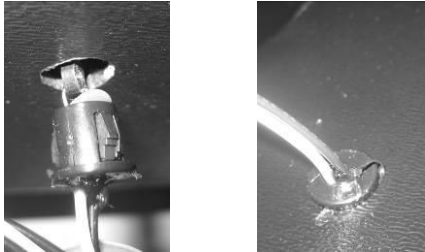

STEP 2: INSTALLING THE FLOOR SENSORS

Push a clip type temperature sensor onto the side wall of each opening of the floor duct so that the sensor sits inside the duct at about the center of the opening.

It is recommended to label the free end of the sensor wires to ensure proper connection to the control box later.

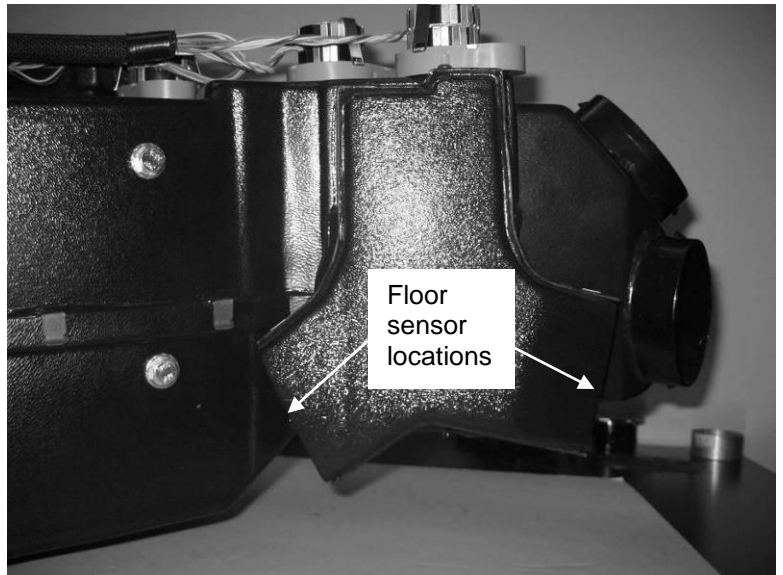

STEP 3: INSTALLING THE CABIN SENSOR

Secure one of the grommet type temperature sensors to the grate of the blower fan using the supplied 6" plastic ties. The sensor should be mounted so that the silver colored element will be in the incoming airflow to the fan when the fan is running.

Be careful that the plastic tie, the sensor, or its wires will not contact the fan blades when the fan is running.

Label the wires for the Cabin Sensor for easier identification later.



STEP 4: INSTALL THE GEN-IV-V MODULE

Install the GEN-IV-V module if it has not yet been installed in the vehicle. Refer to the installation manual for the GEN-IV-V module for detailed instructions for your application.

STEP 5: INSTALL THE VENT SENSORS

The vent temperature sensors are mounted in the flexible duct tubing from the GEN-IV-V module. Determine which two tubes will have the sensor and cut the tubing a **minimum of 6" away** from the GEN-IV-V module. Choose tubes to vents that will blow the most air or blow most directly on passengers in the vehicle.

Of the four included Vent Sensor Housings, use the two that fit the diameter of the cut flexible tubing. Insert the two remaining grommet type temperature sensors into the predrilled holes in these Housings.

Work the Vent Tubes over both ends of the Sensor Housing and secure the tube on both sides of the housing using the provided 11" plastic ties. Make sure the plastic ties are positioned over the body of the Sensor Housing so the raised end of the Housing holds the Tube from slipping off.



STEP 6: MOUNT THE CONTROL BOX

Find a location to mount the DCC control box where the wires will reach without being pulled. There are two tabs on the case of the control box to allow for easier mounting.

STEP 7: WIRE THE TEMPERATURE SENSORS

Wire the temperature sensors wires to the connection strip on the DCC control box. The small tab on the top of the connector can be pressed down with a screw driver to allow insertion of the stripped ends of the sensor wires. Connect the black wire to the "-" terminal. The other wire is connected to the "+" terminal.

Take care when connecting the sensors to the control box. If the sensors are connected to the wrong terminals, the controller will not control the temperature properly. Either Floor Sensor can be connected to either of FLOOR terminal (A & B). Similarly, either Vent Sensor may be connected to either VENT terminal.

STEP 8: MOUNT THE DISPLAY

Determine your mounting location of the display and use the provided cutout template to make the opening for the display. (A diagram of the display mounting is on the cutout template for reference.)

NOTE: *For vertical displays, setup may be easier before completely mounting display (see note in setup).*

Insert the display into the opening from the front of the dash making sure the symbols on the front of the display are in the upright position.

Place a mounting bracket onto each of the studs so that the two legs of the bracket contact the dash panel along the sides of the display unit.

Place a thumb nut onto each of the studs to hold the bracket in place. Tighten the thumb nut to push the bracket up against the back of the dash panel to secure the display in place.

STEP 9: WIRING

Refer to the wiring diagram on previous pages for guidance on the connections described below.

Connect one end of the Display Harness to the display. Route the other end of the cable to the DCC-control box and plug it into the control box connector labeled "DISPLAY CONNECTOR."

Connect the 14 pin connector of the DCC controller harness to the connector labeled "GEN-IV-V CONNECTOR".

Route the DCC controller harness to the GEN-IV-V module.

Connect the 12 pin wire connector to the 12 pin connector on the GEN-IV-V module.

Connect the 16 pin wire connector to the 16 pin main wiring harness connector on the GEN-IV-V.

Connect the GEN-IV-V harness into the remaining 16 pin connector on the DCC controller harness.

If not already wired, wire the GEN-IV-V wiring harness as described in the GEN-IV-V manual.

OPERATION:

FEATURE DIAGRAM:

1. AC / ECON button
Press to toggle between AC on or off modes
2. AC symbol
Lights when AC is on
3. Mode indicator
Lights when adjustment knob controls GEN-IV-V mode
4. Temperature indicator
Lights when adjustment knob controls temperature
5. Fan indicator
Lights when adjustment knob controls fan speed
6. Adjustment knob
When turned, changes current setting
When pushed, moves to next setting
7. Display
Shows current setting and other operating data
8. Status light
Indicates current status of DCC control unit

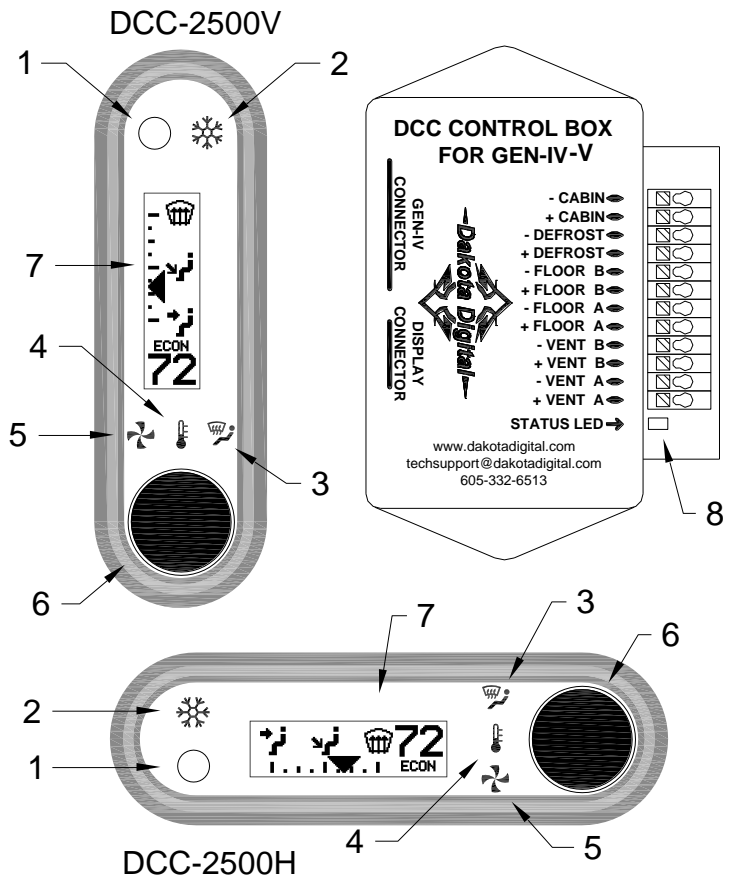

ADJUSTMENT MODES:

There are three adjustment modes which can be selected by pressing the adjustment knob. Each press and release of the knob cycles through one of the adjustment modes and changes the display as indicated below. The selected setting is closest to the knob for each mode.

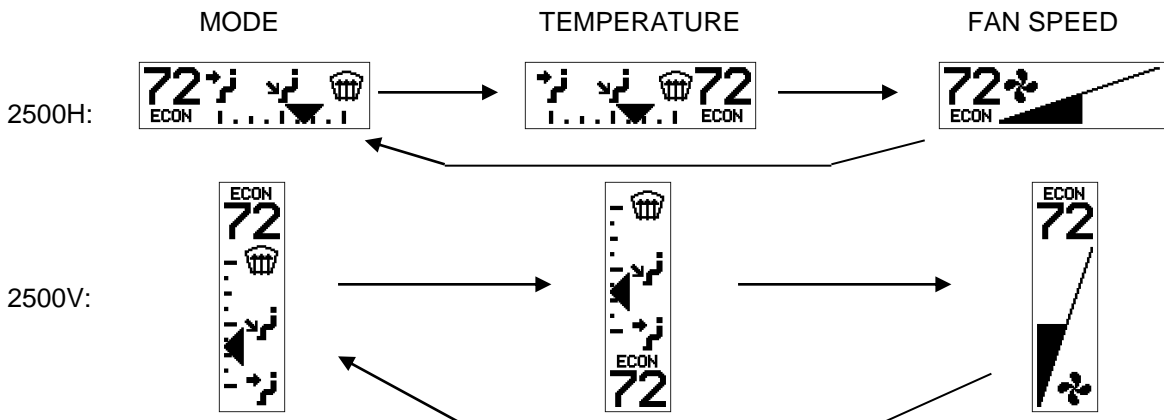

MODE ADJUSTMENT:

In mode adjustment, turning the knob clockwise will move the slider toward the defrost mode. Turning the knob counter clockwise will move the slider toward the vent mode. If the slider is in the middle, floor mode is selected. Any blended mode along the scale may be chosen.

The mode selection is automatic when the system is turned on. Any adjustments to the mode will stop the automatic selection and keep the mode at that setting until the system is turned off and back on again.

TEMPERATURE ADJUSTMENT:

In temperature mode, turning the knob will change the temperature setting. A counter clockwise turn will decrease the temperature setting. A clockwise turn will increase the temperature setting.

A setting at 60F (16C) will put the system in full cool mode. The controller will cause the GEN-IV-V module to be driven in maximum A/C regardless of the temperature readings from the sensors.

A setting of 90F (32C) will put the system in full heat mode. The controller will cause the GEN-IV-V module to be driven to maximum heat regardless of the temperatures reading from the sensors.

For all other temperature settings, the controller will work toward maintaining the air in the cabin at that set temperature.

FAN ADJUSTMENT:

In fan adjustment mode, turning the knob will change the fan speed. A counter clockwise turn will increase fan speed. A clockwise turn will decrease it. Turning the fan speed all the way down will turn the system off.

If the fan speed is under automatic control, "AUTO" will appear in the fan speed scale. Making adjustments to the fan speed will take the fan out of auto mode and the "AUTO" will no longer be displayed. The fan will return to auto mode if an adjustment is made to the temperature setting.

AUTOMATIC FAN:

The fan speed is automatically controlled by the DCC control unit for temperature control. However, the fan speed can be temporarily set to a desired faster or lower speed using the fan adjust mode. The fan will stay at this set speed until an adjustment is made to the set temperature. After an adjustment to the set temperature, the fan speed will return to automatic control.

SETUP:

NOTE: *Due to display limitations and readability, the setup menu in vertical displays will read with the left edge of the display as down. For this reason, it may be easier to do the initial setup before installing the display.*

To enter the setup menu, press and hold the AC/ECON switch while turning the key ON (do not start engine). The screen will display "SETUP." Release the AC/ECON switch and the system will enter the setup menu.

To scroll through the options in the setup menu, turn the knob. The currently active option will be highlighted. To select the option for change or viewing, press the knob while the option is highlighted. Settings that allow change can be adjusted by turning the knob.

After the setting has been set as desired, press the knob again to save the setting and return to the main setup menu.

When finished with setup, turn the key off. The system will return to normal operation with the new settings the next time the key is turned on.

Below is a brief description of the available menu options:

CONTRAST	Setting for the contrast of the LCD display. The contrast of the screen may need to be adjusted for the viewing angle of the display for the best readability.
TEMP F or TEMP C	Allows selection of temperature scale used in display. When highlighted, push the knob to toggle between TEMP F (Fahrenheit) and TEMP C (Celsius). Factory default is TEMP F .
T SPAN	Setting for temperature beyond set point at which the operation mode will change from heating to cooling or vice versa. If the system seems to often change between heat and cool mode, set this to a higher value. Range is 1.0F(0.5C) to 5.0F(2.7C). Default is 2.0F(1.1C)
SET DIM	Setting for the brightness of display when dimming for night time driving. This display brightness will only be used when 12V is on the park light circuit in the GEN-IV-V harness.
SWR VER	Displays the software versions for the display and controller. This information may be needed when calling Dakota Digital for technical assistance.
CALIB	Select this option to begin GEN-IV-V calibration. (takes approximately 18 seconds) See "calibration of GEN-IV-V" below for more details.

CALIBRATION OF GEN-IV-V UNIT:

The GEN-IV-V module is capable of having its control inputs calibrated to a specific control setup. The factory default calibration of most GEN-IV-V modules should match the control method used by the DCC controller and shouldn't need calibration.

Some applications for the GEN-IV-V however use different calibrations to match the manual control levers or knobs used. These GEN-IV-V modules will then read the control signals from the DCC controller incorrectly and behave in unexpected ways. If the DCC unit is being installed into a previously installed and operating GEN-IV-V system or the system seems to not behave as expected, it is advised to calibrate the GEN-IV-V unit to the DCC controller.

Calibration is fully automated with the DCC controller and takes about 18 seconds. Simply put the system into setup mode (as described under SETUP) keeping the engine OFF, and select "CALIB" from the menu.

The screen will display a wait message while calibrating and the fan will run and change speeds several times during calibration. When calibration is complete, the system will return to the setup menu. Turn the key off and the GEN-IV-V module should now be calibrated to the DCC controller.

TROUBLESHOOTING:

Problem	Possible cause	Solution
Display doesn't light.	Control box not connected or has no power.	Status light should blink once every 4 seconds with the key off and come on solid when key is on. If not check harness connection to control box and verify proper connections on GEN-IV-V wiring harness.
	Display harness is not connected or damaged.	Check display harness for proper connections and for cuts or pinched locations.
Status light flashes rapidly and controller doesn't respond.	DCC has inadvertently entered a factory test mode and needs to be reset.	Unplug the DCC controller harness from the DCC control unit. Wait for 2 seconds and then reconnect the harness to controller.
Display is dark or too dim.	Dim setting is set too low.	Go into setup and adjust dim setting.
AC or ECON changes back shortly after pressing AC/ECON button.	Controller is currently in a mode that doesn't allow overriding the AC / ECON function.	Try changing the temperature setting, especially if the temp setting is set to 60F (16C) or 90F (32C).
Fan speed only seems to blow at a slow speed.	Fan may have been manually set to a low speed.	Go to the temperature adjust screen and adjust the temperature to re-enable auto fan control.
Display reads "OFF" and fan doesn't run.	System has been turned off.	Turn or push the knob to turn system back on.
System switches between blowing on the floor and through the vents often.	The temperature span may be set too small for your vehicle.	Go into setup and set the temperature span to a higher value.
Display reads "COMM ERROR"	Communication between the display and controller was lost.	Check the display harness for damage or pinched locations and for proper connection.
Display reads "CABIN / VNT A / VNT B / FLR A / FLR B / DFRST OPEN"	Listed sensor appears disconnected.	Check the connection of the sensor wires for the sensor listed. Also check the sensor wires for breaks or pinched areas.
Display reads "CABIN / VNT A / VNT B / FLR A / FLR B / DFRST OPEN"	Listed sensor appears shorted to ground.	Check for proper connection of listed sensor and check for pinched wires.
Controller doesn't remember temperature setting from when vehicle was last driven.	Constant power was lost to control box.	Ensure the +12v constant power of the GEN-IV-V harness has +12v with key off. The status LED on controller should blink once every 4 sec.
Fan speed, air output location, or temperature does not seem to match settings.	The GEN-IV-V may not be correctly calibrated to the DCC control signals.	Enter setup as described in "SETUP" section and keep engine off. Select "CALIB" from the menu to recalibrate the GEN-IV-V module to the DCC control signals.
System doesn't cool, even when set to lowest temperature setting.	GEN-IV-V may need calibration. Air conditioning system may need to be charged or may not be setup properly.	See "CALIBRATION" in setup section. Refer to the GEN-IV-V manual regarding system charging and troubleshooting.
Fan speed is low at startup.	DCC keeps fan low until the GEN-IV-V unit output air begins to change toward desired temperature.	This is normal operation and is done to prevent uncomfortable blasts of hot or cold air when the opposite is desired at start up.
Display is very dark or very light and hard to read.	Contrast needs to be adjusted for your particular viewing angle.	Enter setup and adjust the contrast using the contrast option.

DCC Specifications		
SUPPLY		
Voltage Range (BAT)	8 to 18 V	
Ignition	> 5 V	
INPUTS		
	Low Max	High Min
DIM (dash lamp)	3.1 V	3.8 V
CURRENT DRAW		
IGN off	≈ 0.2 mA	
IGN on	≈ 200 mA	

SERVICE AND REPAIR

DAKOTA DIGITAL offers complete service and repair of its product line. In addition, technical consultation is available to help you work through any questions or problems you may be having installing one of our products. Please read through the Troubleshooting Guide. There, you will find the solution to most problems.

Should you ever need to send the unit back for repairs, please call our technical support line, (605) 332-6513, to request a Return Merchandise Authorization number. Package the product in a good quality box along with plenty of packing material. Ship the product by UPS or insured Parcel Post. Be sure to include the RMA number on the package, and include a complete description of the problem with RMA number, your full name and address (street address preferred), and a telephone number where you can be reached during the day. Any returns for warranty work must include a copy of the dated sales receipt from your place of purchase. Send no money. We will bill you after repair.

Dakota Digital 24 Month Warranty

DAKOTA DIGITAL warrants to the ORIGINAL PURCHASER of this product that should it, under normal use and condition, be proven defective in material or workmanship within 24 MONTHS FROM THE DATE OF PURCHASE, such defect(s) will be repaired or replaced at Dakota Digital's option.

This warranty does not cover nor extend to damage to the vehicle's systems, and does not cover removal or reinstallation of the product. This Warranty does not apply to any product or part thereof which in the opinion of the Company has been damaged through alteration, improper installation, mishandling, misuse, neglect, or accident.

This Warranty is in lieu of all other expressed warranties or liabilities. Any implied warranties, including any implied warranty of merchantability, shall be limited to the duration of this written warranty. Any action for breach of any warranty hereunder, including any implied warranty of merchantability, must be brought within a period of 24 months from date of original purchase. No person or representative is authorized to assume, for Dakota Digital, any liability other than expressed herein in connection with the sale of this product.

⚠ WARNING: This product can expose you to chemicals including lead, which is known to the State of California to cause cancer and birth defects or other reproductive harm. For more information go to www.P65Warnings.ca.gov



4510 W. 61st St. North
 Sioux Falls, SD 57107
www.dakotadigital.com
dakotasupport@dakotadigital.com

Phone (605) 332-6513
 Fax (605) 339-4106

© Copyright 2023 - Dakota Digital